

TRANSIT 4

User Manual



HEARTWAY



Contents

Information	P1
Safety Instruction	P3
Electromagnetic Interference	P9
Product Specification	P11
Adjustment	P12
Operation of Control	P15
Brake & Battery Connection	P17
Battery & Charging Instruction	P18
Indicator Signal	P21
Maintenance & Repair	P24
BOM List	P27
Warranty Declaration	P28



Manufacturer: Electrically powered scooter Class A (EN 12184)



Heartway Medical Products. Co. Ltd. No 18th Jingke Central 1st Road
Nantun Dist. Taichung City 408, Taiwan ROC.



The users need to consult the instructions of the device for information on how to use it properly

Moving of adult disabled persons by self-driving. Maximum user weight: 115 kg; Classified in Class A (EN12184) Maximum safe slope: 3°
(Not intended for outdoor use).

The product is not intended for visually impaired people. The drivers need to be mentally and physically suitable to drive the scooters. The fingers need to work functionally. The device can't be used by children until age of 12. The driving distance will be reduced if the power scooter is used frequently on slopes, rough ground or to climb kerbs. The scooter is not for use as a seat in motor vehicle.



WARNING



All adjustments can be adjusted by both occupant and assistant. This vehicle is suitable for land and/or air transport.

Please refer to our official website for general product information at www.heartway.com.tw

- ⇒ Don't operate your power scooter without completely reading and understanding this user manual!
- ⇒ Do not operate the scooter with depleted batteries, since the occupant could be stranded.
- ⇒ The end user is NOT allowed to change the parameter.
- ⇒ The occupant can switch off the key to stop the scooter for any emergency stop please remove the battery package from the scooter unit before long term storage.
- ⇒ **Notice to the user and/or patient that any serious incident that has occurred in relation to the device should be reported to the manufacturer and the competent authority of the Member State in which the user and/or patient is established**
- ⇒ S21F should be turned off prior to entering or existing the seat. Make sure the scooter is fully un-folded before driving.
- ⇒ For detailed product safety notice and product recalls, please contact your local authorized distributor direct. The recall notice should include the following information: Product description, including the name, make, model and any distinguishing features, batch, or serial numbers. The power scooter has provision for an anterior pelvis support to be fitted such as belt
- ⇒ The power scooter has provision for an anterior pelvis support to be fitted such as belt

WARNING

- ⇒ Environmental conditions may affect the safety and performance of your power scooter. Water and extreme temperatures are the main elements that can cause damage and affect performance.
- ⇒ A) Rain, Sleet and Snow:
 - ⇒ If exposed to water, your power scooter is susceptible to damage to electronic or mechanical components.
 - ⇒ Water can cause electronic malfunction or promote premature corrosion of electrical components and frame.
- ⇒ B) Temperature:
 - ⇒ Some of the parts of the power scooter are susceptible to change in temperature.
 - ⇒ The controller can only operate in temperature that range between -20°C and $+45^{\circ}\text{C}$
 - ⇒ At extreme low temperatures, the batteries may freeze, and your power scooter may not be able to operate.
 - ⇒ In extreme high temperatures, it may operate at slower speeds due to a safety feature of the controller that prevents damage to the motors and other electrical components.



The following symbols are used in the scooter to identify warnings, mandatory actions and prohibited actions. It is very important that you read and understand them completely.



Read and follow the information in the instruction manual.



Caution. Observing notes and accompanying documents

Scooter Class A

It is classified in category A according to EN 12184. It is compact, maneuverable and not necessarily able to overcome obstacles outdoors



For ambient conditions

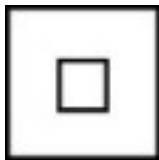

Protection class II



Charger IPX0 "Protect from moisture" / Scooter IPX4 "Splashproof"



Does not meet the ISO 7176-19 standard and cannot be used as a seat in a motor vehicle. Labeling on the product.



Devices for decommissioning the drive system
Warning: Switch on the drive system again before leaving a user unattended.



Charge the batteries fully before use.
Remove the key from an unattended scooter.



Year of manufacture see label on the product.



Heartway Medical Products Co., Ltd.

No.18, Jingke Central 1st Rd., Nantun Dist.Taichung City
40852,Taiwan (R.O.C.)

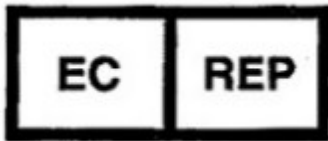

Europäischer Bevollmächtigter / Authorized Representative
Emergo Europe Prinsessegracht 20 2514 AP The Hague
The Netherlands

The scooter S21F is designed for indoor use for adults with mobility restrictions. It is classified in category A according to EN 12184. It is compact, maneuverable and not necessarily able to overcome obstacles outdoors; The maximum load is 115 kg.

INDICATIONS

Inability to walk or severe walking disability due to

- paralysis
- Loss of limbs
- extremity defect / deformity
- joint
- joint damage (not on both arms)
- other diseases

A supply with a scooter (or also electric wheelchairs) is indicated when the use of hand-driven wheelchairs is no longer possible due to the disability, but the correct operation of an electric motor drive is still possible.

CONTRAINDICATIONS

The supply of scooters is unsuitable for people:

- with severe balance problems
- with reduced and insufficient eyesight
- with severe cognitive impairments

CONFORMITY

This mobility meets the requirements of EN 12184: 2014 and the requirements for class I medical devices in accordance with Class I of Regulation MDR 2017/745 annex VIII.

◆ General



Always use a seat belt and keep your feet on the scooter all the time.



Never operate the scooter while you are under the influence of alcohol.



Never use electronic radio transmitters such as walkie-talkies, or cellular phones.



Do not ride your scooter in traffic.



Do not attempt to climb curbs greater than limitation show on Technical Specification.



Do not leave your hands and legs off the scooter when driving.



Make sure that there are no obstacles behind you while reversing your scooter.



Do not make a sharp turn or a sudden stop while riding your scooter.



Do not rider your scooter during snow in order to avoid accident on slippery road.



Do not allow unsupervised children to play near this equipment while the batteries are charging.



WARNING

1. Don't operate scooter on public streets and roadways. Be aware that it may be difficult for traffic to see you when you are seated on the scooter. Obey all local pedestrian traffic rules. Wait until your path is clear of traffic, and then proceed with extreme cautions.
2. To prevent injury to yourself or others, always ensure that the power is switched off when getting on or off of the scooter.
3. Always check that the drive wheels are engaged (drive mode) before driving. Do not switch off the power when the scooter is still moving forward. This will bring the chair to an extremely abrupt stop.
4. Do not use this product or any available optional equipment without first completely reading and understanding these instructions. If you are unable to understand the warnings, cautions or instructions, contact a healthcare professional, the dealers or technical supports before attempting to use this equipment, otherwise, injury or damage may occur.
5. There are certain situations, including some medical conditions, where the scooter user will need to practice operating the scooter in the presence of a trained attendant. A trained attendant can be defined as a family member or care professional especially trained in assisting a scooter user in various daily living activities. Consult with your physician if you are taking any medication that may affect your ability to operate your scooter safely.
6. Do not attempt to lift or move a power scooter by any of its removable parts including the armrests, seats or shrouds. Personal injury and damage to the power chair may result.
7. Never try to use your scooter beyond its limitations as described in this manual.
8. Please do not sit on your scooter while it is in a moving vehicle.
9. Keep your hands away from the wheels (tires) while driving scooters. Be aware that loose fitting clothing can become caught in the drive tires.
10. Consult your physician if you are taking prescribed medication or if you have any certain physical limitations. Some medications and limitations may impair your ability to operate scooters in a safe manner.
11. Be aware when the drive mode is unlocked or locked.
12. Don't remove anti-tipper if there is any-tipper equipped with the scooter.
13. Contact with tools can cause electrical shock and do not connect an extension cord to the AC/DC converter or the battery charger.
14. Do not attempt to lift or move your scooter by any of its removal parts, such as the armrests, seats, or shroud.
15. When climbing an incline, don't drive at an angle up the face of the incline. Drive your scooter straight up the incline. This greatly reduces the possibility of a tip or a fall.
16. Don't climb a slope steeper than the scooter's limitation.
17. Don't attempt to have your scooter proceed backward down any step, curb or other obstacle. This may cause the scooter to fall or tip.
18. Always reduce your speed and maintain a stable center of gravity when cornering sharply. Don't corner sharply when driving scooters at higher speeds.

19. Operating in rain, snow, salt, mist conditions and on icy or slippery surfaces may have an adverse affect on the electrical system.
20. Never sit on your scooter when it is being used in connection with any type of lift or elevation product. Your scooter is not designed with such use in mind and any damage or injury incurred from such use is not the responsibility of Heartway.
21. Surfaces of the power scooter that can come into direct contact with the occupant's skin and/or assistant's skin during normal use and that are within occupant reach shall not exceed 41 °C. The motor surface can reach temperatures greater than 41°C after driving. Do not touch these parts when disassembling the scooter or wait until the motor is cooled down.
22. The programming of the controller shall only be carried out by personnel, which is authorized by his manufacturer. A wrong programming can result in safety hazards for the occupant!
23. Drive-wheel needs to be switched to engaged-mode while transporting the power scooter with a car or airplane.
24. Surface temperatures can increase when exposed to external sources of heat.

IMPORTANT NOTICE

Heartway Medical Product has designed and engineered power scooter to provide maximum utility. However, under no circumstances should you modify, add, remove, or disable any part or function of your power scooter. Personal injury and damage to the power scooter may result.

1. Do not modify your power scooter in any way not authorized by Heartway. Do not use accessories if they have not been tested or approved for Heartway products. Changing of controller parameter shall be only performed by authorized technicians due to the safety concern.
2. Get to know the feel of your power scooter and its capabilities. Heartway recommends that you perform a safety check before each use to make sure your power scooter operates safely.

◆ Inspections prior to using your power scooter:

1. If equipped with pneumatic tires, please check for proper tire inflations.
2. Please check all electrical connections and make sure they are tight and not corroded.
3. Please check all harness connections and make sure they are secured properly.
4. Please check the brakes.

◆ Weight limitation.

1. Please refer to the specifications table for weight capacity information. Power scooter is rated for a maximum weight capacity.
2. Stay within the specified weight capacity for your scooter. Exceeding the weight capacity voids your warranty.
3. Heartway will not be held responsible for injuries or property damage resulting from failure to observe weight limitations.
4. Don't carry passengers on scooters.
5. Carrying passengers on scooter may affect the center of gravity, resulting in a tip or a fall.

◆ Tire inflation

1. If your scooter is equipped with pneumatic tires, it is necessary to check the air pressure at least one time a week.
2. Proper inflation pressures will prolong the life your tires and ensure the smooth operation while riding.
3. Inflating your tires from an unregulated air source could over-inflate them, resulting in a burs tire.

◆ Temperature



1. Some of the parts of the power scooter are susceptible to change in temperature. The controller can only operate in temperature that ranges between -20°C ~ 45°C .
2. At extreme low temperatures, the batteries may freeze, and your power scooter may not be able to operate. In extreme high temperatures, it may operate at slower speeds due to a safety feature of the controller that prevents damage to the motors and other electrical components.
3. The scooter can generally be operated at outside temperatures from -10° to $+45^{\circ}\text{C}$.
4. Some parts of the scooter tend to be temperature dependent. The controller works best at temperatures between 25°C and 45°C .
5. Below -15°C the batteries can freeze and the scooter may not work.
6. At extremely high temperatures $> 45^{\circ}\text{C}$, the safety function of the control, which prevents damage to the motors and other electrical components, can lead to slower maximum speeds.

The rapid development of electronics, especially in the area of communications, has saturated our environment with electromagnetic (EM) radio waves that are emitted by television, radio and communication signals. These EM wave are invisible and their strength increases as one approach the source. All electrical conductors act as antennas to the EM signals and, to varying degrees, all power scooters and scooters are susceptible to electromagnetic interference (EMI). The interference could result in abnormal, unintentional movement and/or erratic control of the vehicle. The United States Food and drug Administration (FDA) suggests that the following statement be incorporated to the user's manual for all power scooter like the S21F. Power scooters may as susceptible to electromagnetic interference (EMI), which is interfering electromagnetic energy emitted from sources such as radio stations, TV stations, amateur radio (HAN) transmitter, two-way radios, cellular phones and alarm systems of shops. The interference (from radio wave sources) can cause the power scooter to release its brakes, move by itself or move in unintended directions. It can also permanently damage the powered scooter's control system. The intensity of the EM energy can be measured in volts per meter (V/m). Each powered scooter can resist EMI up to a certain intensity. This is called "immunity level". The higher the immunity level the greater the protection. At this time, current technology is capable of providing at least 20 V/m of immunity level, which would provide useful protection against common sources of radiated EMI.

Following the warnings listed below should reduce the chance of unintended brake release or powered scooter movement that could result in serious injury:

1. Do not turn on hand-held personal communication devices such as citizens band (CB) radios and cellular phones while the powered scooter is turned on.
2. Be aware of nearby transmitters such as radio or TV stations and try to avoid coming close to them.
3. If unintended movement or brake release occurs, turn the powered scooter off as soon as it is safe.
4. Be aware that adding accessories or components, or modifying the powered scooter, may make it more susceptible to interference from radio wave sources
(Note: It is difficult to evaluate the effect on the overall immunity of the powered scooter).
5. Report all incidents of unintended movement or brake release to the powered scooter manufacturer, and note whether there is a radio wave source nearby.

TURN OFF YOUR POWERED SCOOTER AS SOON AS POSSIBLE WHEN EXPERIENCING THE FOLLOWING:

- Unintentional scooter movements.
- Unintended or uncontrollable direction.
- Unexpected brake release.

The FDA has written to the manufacturers of power scooters asking them to test new products to be sure they provide a reasonable degree of immunity against EMI. The FDA requires that a powered scooter should have an immunity level at least 20 V/m, which provides a reasonable degree of protection against more common sources of EMI. The higher the immunity level the greater the protection. Your powered scooter has an immunity level of 20 V/m which should protect against common sources of EMI.

WARNING

- The scooter itself can disturb the performance of the electromagnetic fields such as emitted by alarm systems of shops.
- The driving performance of the scooter can be influenced by electro magnetic fields.

S21F seat is tested according to EN 1021 regarding resistance to ignition, but it is recommended to avoid the use of flame near the power scooter and of smoking during sitting on the power scooter.

Remarks: The stability tests were performed in the least stable positions of the seat (height and front/rear position).

The distance will be reduced if the scooter is used frequently on slopes, rough ground or to climb the kerbs.

WARNING

The stopping distance on the slope can be significantly greater than on the level ground.

Indication/ Intended Purpose:

Moving of disabled by self driving.

This medical equipment is intended to provide mobility to persons restricted to a seated position, e.g. for patient, especially for the leg disabled person.



MODEL	S21F - Auto Folding Scooter
WEIGHT CAPACITY	115kgs
SEAT: TYPE/SIZE	16"
DRIVE WHEEL	PU 200mmx50mm(8"x2")
FRONT CASTER (WHEEL)	PU 180mmx40mm(7"x1.6")
REAR CASTER (ANTI-TIPPER)	YES
MAX SPEED	6 KM/H
BATTERY SPECIFICATIONS	10.05 AH Li-Polymer
BATTERY RANGE	10KM
CHARGER TYPE	2Amp, 110/240 Volt, Li-ION Charger
CONTROLLER TYPE	Dynamic 50Amp
MOTOR TYPE	180W
WEIGHT: W/ BATTERY	23 KG
WEIGHT: W/O BATTERY	21.3KG
Battery (removable, the heaviest part)	1.7KG
TURNING RADIUS	1000 mm
SUSPENSION	None
LENGTH	840mm
WIDTH	460mm
HEIGHT	770mm
FOLDED SIZE	730mm x 460mm x 465mm
SEAT WIDTH	400mm
SEAT HEIGHT	370mm
SEAT DEPTH	320mm
BACK HEIGHT	220mm
WHEEL BASE	560mm
Obstacle Climbing	30 mm
Max Safe Slope	3 Degree
LIFE TIME	5 Year

Folding Out the Scooter



Position the scooter with rear wheels and anti-tipper wheels on the ground



Switch off the scooter using the key and lift up the backrest (highlighted in the diagram right)

Insert the key into the ignition of the scooter and switch the scooter on. The green button (arrowed below) on the scooter should now be illuminated. Press this for 3 seconds then release the button and the scooter will automatically fold out.

Alternatively, press the green button on the remote. (in case of emergency, press the red button on the rear of the scooter to stop the folding procedure, If this happens , remove the hazard and keep your finger on the green button until the scooter is fully folded out.

Folding Up the Scooter



The user should vacate the scooter. Folding down the backrest of the seat (highlighted on the diagram below)



The red button (arrowed below) on the scooter should now be illuminated. Press this for 3 seconds then release the button and the scooter will automatically fold up. Alternatively, press the red button on the remote. (If case of emergency, press the green button on the rear of the scooter the stop the folding procedure. If this happens, remove the hazard and keep your finger on the red button until the scooter is fully folded up).



Switch the scooter off using the ignition and remove the key. Turn the stand-by on/off switch (located next to the charger port) to the off position

WARNING

- PLEASE TURN OFF THE POWER BEFORE FOLDING/UNFOLDING POWER SCOOTER
- PINCH POINT-BE AWARE OF FINGERS WHEN FOLDING AND UN-FOLDING POWER SCOOTER



- Two persons are needed to lift this power scooter – S21F
- Never open the battery box. If you have any question, please contact your local authorized dealer or technical supports for further support and assistance.
- The power scooter needs to be folded properly before any transporting.

Storage

Your power scooter should be stored in a dry place, free from temperature extremes. When storing, disconnect the batteries from the power scooter. If you fail to store the unit properly, the frame can rust and the electronics can be damaged.

Batteries that are regularly and deeply discharged, infrequently charged, stored in extreme temperatures, or stored without a full charge may be permanently damaged, causing unreliable performance and limited service life.

It is recommended that you charge the batteries periodically throughout periods of prolonged storage to ensure proper performance. You may wish to place several boards under the frame of your power scooter to raise it off of the ground during periods of prolonged storage.

Seat Belt

Seat belt is regarded as optional accessory for S21F power scooter. Seat belt can be installed onto the seat (see photo below). Please consult with the local authorized dealer for safety belt installation.



If you plan on not using your power scooter for an extended period of time, it is best to: Fully charge its batteries prior to storage. Disconnect the batteries from the scooter.

Store your power scooter in a warm, dry environment. Avoid storing your power scooter where it will be exposed to temperature extremes. Operating conditions (-10 °C ~ +45°C) and Storage conditions(-40 °C~+65 °C) Make sure the batteries are fully charged before use after long-term storage. Batteries that are regularly and deeply discharged, infrequently charged, stored in extreme temperatures, or stored without a full charge may be permanently damaged, causing unreliable performance and limited service life. It is recommended that you charge the power scooter batteries periodically throughout periods of prolonged storage to ensure proper performance.

The power scooter is simple to operate. However, we recommend that you read carefully the following instructions to become familiarized with your new vehicle. Please do not operate this power scooter if it is behaving abnormally or erratically.

The following operation can be carried out either by assistant or occupant .

A Word of Caution:

Before you turn the power on, always be aware of the environment that surrounds you to select your desired speed. For indoor environments we recommend that you select the slowest speed setting. For outdoor operation of this vehicle we recommend that you select a speed that is comfortable for you to control it safely.

The following steps are required to operate your vehicle safely with the controller.

Button functions

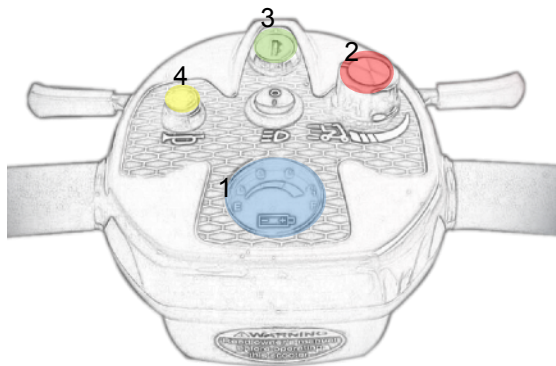

B. KEY ON

Insert the key and rotate it clockwise to power on the scooter. To turn off the scooter rotate the key anti clockwise.

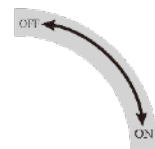

1. **Battery Indicator:** When your scooter is switched on, the needle on the meter will move across the scale from the left 'red' sector towards the 'green' sector, indicating the state of charge in your batteries. As the power is used up in your batteries, the needle will slowly towards the 'red' sector indicating the state of charge at that precise time. When the needle is fully over to the right, the batteries are fully charged. When the needle falls towards the red sector, your batteries are losing power, but you will still have power to spare. When the needle falls into the red sector, your batteries are low in power and need to be recharged. It is wise to recharge your batteries when the needle enters the red zone (see Batteries and Battery Charging section of this manual).
2. **High/Low Speed Adjustment:** This allows you to pre-select your desired speed. The adjuster is proportional to speed and can be set anywhere between minimum and maximum. Turn the adjuster knob counter-clockwise to minimum for a very gentle operation, and clockwise towards maximum to increase your speed.
3. **Power ON/OFF Light:** The light will turn on if you insert the key. The light will turn off if you take out the key.
4. **Horn button:** Press this button to sound the horn.(Easy operation for left hand or right hand)

A Controller ON/OFF Switch

Insert the key to power on the scooter (Remove the key to power off). Swing the finger lever control forward or backward to control the driving direction of the scooter (The finger lever control is located at both sides of the controller and the returning of the finger lever control to its neutral position,(center), will reduce the speed and stop the vehicle by automatically applying the electro-magnetic brakes



Finger Lever Control/Maximum
Force Applied on Lever is 4N

B Speed Control

Turn the adjuster knob clockwise towards maximum to increase your speed, and counter-clockwise toward minimum to slow down your speed.

C Finger Lever Control

The finger lever control can also control the speed of your vehicle. The deeper you press on the finger lever (forward / backward), the faster the vehicle will go.

Notes:

- After inserting the key into controller ON/OFF port, the light of power ON/OFF will turn on for a few seconds during self-checking process.
- When the vehicle is in operation, the surface of the charger will become slightly warm.
- In case of emergency, let go of the finger lever control and the vehicle will come to a stop.
- DO NOT touch the rear shroud while driving. It may be hot.

Control Panel Display

The control panel display is a multifunction visual display. It can provide a lot of information of the vehicle.

When the needle falls into the red sector, your batteries are low on power and need to be recharged. It is wise to recharge your batteries when the needle enters the red zone. The remaining battery needle only goes lower when using the battery, regardless the battery voltage. The remaining battery meter needle goes higher only when recharging battery in progress.

System will power off when the battery voltage is lower than 21.0V.

System will be automatically power-off when the vehicle is not in use over 30 minutes. You need to remove the key and insert the key to restart the scooter.

Free-Wheeling:

- ⇒ The motors are designed to engage the electromagnetic brakes when the vehicle is not in use or when the power is OFF. They also have a manual feature that allows them to “free-wheel” so the scooter can be moved without turning it on. Free-wheeling is accomplished by adjusting the free-wheeling switch to the free-wheeling position.
- ⇒ Engaging in freewheel mode will have the function as parking brake.



WARNING

- ◇ Never free-wheel your power scooter on a slope.
- ◇ Never free-wheel the motors while operating your vehicle.
- ◇ Always remember to engage the motors before turning the power ON.
- ◇ PLEASE TURN OFF THE POWER BEFORE FOLDING/UNFOLDING POWER SCOOTER



In Case the switch (see the attached photo) is turned to FREE-WHEEL mode (accidentally) while driving, the error code will be activated to remind the user to stop driving. However, the scooter will not stop operation automatically while the user switch the DRIVE mode to FREE-WHEEL mode accidentally.

Electromagnetic Brakes:

Your power scooter comes with Electromagnetic Brakes., i.e. an automatic magnetic disc safety brake which is also known as Fail-Safe brake. The electro-magnetic Brakes are automatic and work when the power scooter is ON but in a steady state (i.e. Wigwag is released to the neutral position), even when the scooter is on a slope. The Electromagnetic Brakes will also be set whenever the power scooter is OFF, but the motor levers are in the engaged (vertical) position.

Parking brake:

There is an automatic parking brake function included in the electromagnetic brake. The scooter will stop when the motor is engaged and the power switch is off or when the power switch is on and the wigwag is in the neutral position. If the scooter is in the free wheel mode (motor is disengaged), you can use the manual parking brake function by moving the engaging/disengaging lever back into the engaged position by an attendant. The electromagnetic brake will stop the scooter when the wigwag paddle is released to the neutral position

Thermal Protection:

Your power scooter controller is equipped with a safety system called thermal rollback. A built-in circuit monitors the temperature of the controller and motor. In case of excessive heat of the controller and motor, the controller will cut-off the power to allow the electrical components to cool down. Although your power scooter will resume its normal speed when the temperature returns to a safe level, we recommend waiting for 5 minutes before restarting to allow the components to cool down.

We recommend that you use deep-cycle batteries that are sealed and maintenance free for your power scooter.

General product Information:

The equipment is a Rechargeable Li-ion Battery Pack for use in the scope of information technology equipment.

Model:	EBP28A076C1
Cell's arrangement:	7S4P
Minimum capacity (Ah):	11.5
Nominal voltage (Vdc)	25.2
Maximum charge current (A):	6.0
Maximum charge voltage (Vdc):	29.4
Maximum discharging current (A)	20.0
Discharge Cutoff voltage (Vdc):	19.6

Additional Information:

The **battery cell** used in the product is a certified product which was investigated according to the standard of **same version**.

Other Comments:

The mass of equipment: Approx. 1.762kg

Remove the battery box from the power scooter

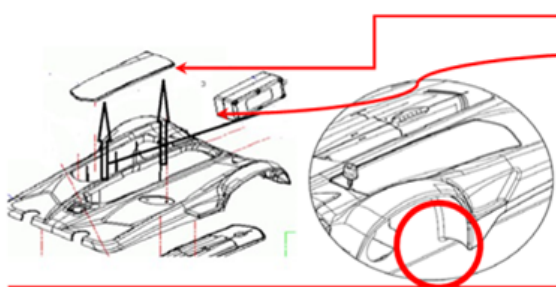

- A) Please lift the side cover**
- B) Lift the battery box (1.7KG) after removing the side cover**

Make sure the battery connectors are connected properly after you install the batteries into the power scooter.

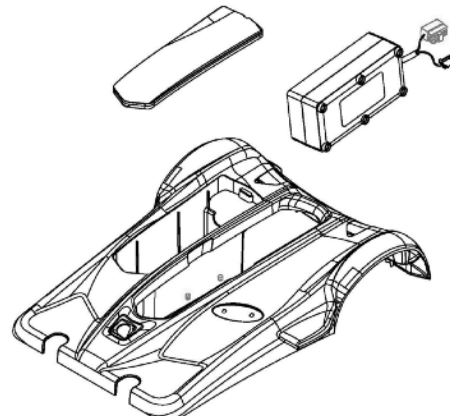



WARNING

DO NOT operate this scooter with depleted batteries since the occupant could be stranded.

Please remove the battery package from the scooter unit before long term storage.



Forbidden! Although the travel scooter has passed the required IPX4 water spray test requirements, keep electrical connections away from sources of moisture, including direct exposure to water or body fluids, and incontinence. Check the electrical components frequently for signs of corrosion and replace if necessary.



Warning! The charger should only be used in a dry interior. Protect from moisture and wetness.

Depending on the use, terrain and driving conditions, the batteries will provide a range of 15 KM of travel.

However, even if the power scooter is not in use, we recommend that the batteries are charged periodically.

Note: Do not use any automotive batteries.

They are not designed to handle a long, deep discharge and also are unsafe for use in power scooter.

The useful life of a battery is quite often a reflection of the care it receives.

FEATURE	MODEL
	HP0060WL2 - 24V/2A
Input AC voltage range	100Vac 240Vac, 50H 60Hz
Output current	2A+0.2A
No-load	29.05V+0.2V
LED Indications	Power on: Red Charging: Orange Full charged: Green
Charge mode	Constant Current, Constant Voltage
Over voltage protection	HAVE
Over current protection	HAVE
Timer in Pre-charge	2Hr
Timer in CC-charge	10Hr
Short circuit protection	Have
Feedback protection	Have
Operating temperature	0'C 40'C
Operating humidity	20%RH 85%RH
Operating altitude	2000M
Dimensions	L128mm* W67mm*H40mm
N.W	0.35KG.
Certificates	cTUVus - TUV • SAA • PSE • CE • FCC • CEC • UKCA CE-IEC60601

BATTERY CHARGER

The battery charger takes the standard wall outlet voltage (alternating current) and converts it into DC voltage (direct current). The batteries use direct current to run your power scooter. When the batteries are fully charged, the amperage from the charger is almost at zero. This is how the charger maintains a charge but does not overcharge the battery.

Note 1: The batteries cannot be charged if they were discharged to nearly zero voltage.

Note 2: The power scooter meet the requirement of ISO 7176-14:2008 and ISO 7176-21:2003.

Note 3: Only use the battery charger type which was provided by the supplier.

The use of any different type of charger can be hazardous and need the approval of the manufacturer.

Electrical Specifications:

1. Input voltage & Frequency

Input voltage range		Frequency range
100Vac	240Vac	47Hz~ 63Hz

2. Efficiency:»88%

3. Input current: 1.2A

4. Input leakage current:60.75mA

5. Output voltage & current

Charge Mode	Output Voltage	Output Current	LED Indications
Ultra low voltage	1.5V ~ 14V±1V	≤ 0.1A	Orange light flash
Pre charge	14V ~19V ± 1V	0.5A±0.2A	Orange light on
CC	19V~28V ± 11V	2A±0.2A	Orange light on
CV	28V~29.05V	Decreasing from2A	Orange light on
Full Charged	29.05V±0.2V	0.25A±0.15A	Green light on
No-load	29.05V±0.2V	0A	Red light on

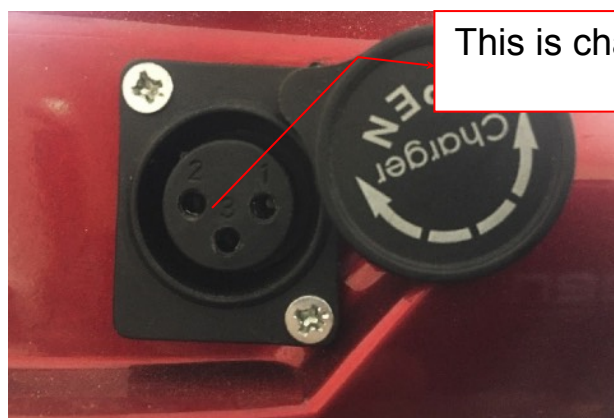

This is charger port

LED Indications

Red light on: Power on, disconnect with the battery

Orange light on: Charging

Green light on: Full-charged

Operating instructions

- 1) Make sure the power cord , charger and battery connector are in good connected.
- 2) Make sure the output voltage of the charger is the same as the connecting battery
- 3) Connect the plug of the charger with battery
- 4) Make sure the input voltage is correct and plug into the electrical outlet, normally the LED(Orange) light will turn on when it is charging.

Troubles shooting

1) RED light is off when power on.

=> Check if the input power cord of the charger has been plug into the socket , and if there have electricity passes from the outlet , if yes , please send the charger to repair.

2) Orange light is off during charging

=> Check if the charger and battery connectors are correctly connected , if they are in good connection , and the battery is not fully charged , the battery maybe defective.

3) Orange light does not turn Green

=> The battery can not be charged, please remove the battery and check to see if the battery is still useable.

4) Orange light turns Green immediately

=> Check to see if the battery is fully charged , if not , the charger maybe defective. Please send the charger back to the manufacturer to repair.

Caution

- 1) For indoor use only , do not expose to rain
- 2) Please switch o0the power supply before removing the charger from the battery.
- 3) Do not get closed to explosive gases or sparks and put the charger in a well ventilated area during charging
- 4) Use the charger only 24V Li-ion batteries.

DC Connector definition (picture attached)

PIN	3PIN
1	Output(+)
2	Output(-)
3	Output(-)

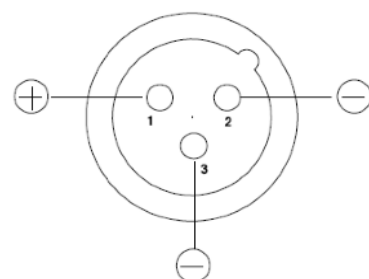

Stickers

LED Sticker



Front Sticker

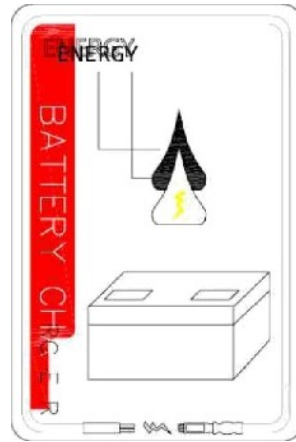

Back Sticker

Class 2 Battery Charger
 MODEL:HP0060W(L2)
 INPUT :100-240VAC
 50-60Hz 1.2-0.5A
 DC OUTPUT: +24V 2A

LED { RED: POWER ON
 R/G: CHARGING
 GREEN: CHARGED

INHBIT

S.

CAUTION:

- Before charging read the instructions
- For indoor use only
- Disconnect the supply before breaking the connections to the battery.
- Protection Fuse: T2.5A/250V
- Charge (24V Li-Ion) Type Rechargeable Batteries Only. Other types of batteries may causing personal injury and damage
- RISQUE DE CHOC ÉLECTRIQUE
 UTILISER DANS UN ENDROIT SEC SEULEMENT POUR UTILISATION À L'INTERIEUR SEULEMENT

WARNING:
 Keep away from explosive gases.To prevent flames and sparks,provide adequate ventilation during charging
 HIGH POWER TECHNOLOGY (KUN SHAN) INC
 No.59,Hua-Cheng East Road,LuJia Town,KunShan City,
 JiangSu Province,China MADE IN CHINA



WARNING

- ◆ Always charge your batteries in well ventilated areas.
- ◆ The charger is intended for indoor use only. Please protect it from the moisture.
- ◆ For maximum performance, it is recommended that you replace both batteries at the same time if the batteries are weak.
- ◆ If the power scooter will not be used for a long period of time, arrange to have the batteries recharge at least once every month to avoid deterioration of the batteries.
- ◆ Can we use a different charger? Please understand that chargers are selected specifically for particular applications and matched to the type and size of specific batteries. In order to charge your power scooter safely and efficiently, we recommend use of the charger supplied as original equipment with your Heartway product only. Any charging method resulting in batteries being charged individually is prohibited.

Note:

- A. Always charge your batteries in well ventilated areas.
- B. The charger is intended for indoor use only. Protect from moisture.
- C. For maximum performance , it is recommended that you replace both batteries at the same time if the batteries are weak.
- D. If the scooter will not be used for a long period of time, arrange to have the batteries fully charge for at least once every month.

According to the battery type and condition of the batteries, batteries usually can be fully charged in 4-10 hours.

This will be indicated when the status light in the battery charger side panel turns green. Charging the battery longer than necessary will not harm the battery.

We recommended that you charge the batteries for 8 to 10 hours after daily use.

Do not charge the batteries for more than 24 hours.

Note: There is a battery circuit diagram labeled on the frame. Please refer this diagram before you assemble the battery

Read through the charger operating instruction before using it.

Make sure you charge the battery every time after you use the power scooter or scooter.

If the charger indicates red light, please kindly check if the charger is defected or if the cable wiring connection is poor.

Please keep the battery terminals clean otherwise the charging condition will be poor.

Caution

Caution on usage of Lithium Ion pack. (or soft pack)

Handing at assembly

- In case of adding strong shock to battery or dropping battery, do not use the battery.
- In case of distorting battery, do not use the battery.
- To prevent from ESD under appropriate work environment and by workers.

Storage

- 1) It shall be kept in shipping condition (within 40%~60% SOC or 25V~26V voltage range) for long period.
- 2) It is recommended to inspect the battery pack every 6 month to ensure battery pack is at the best status for long term storage.
- 3) If battery pack is out of the storage condition, specified in 1), it shall be charged or discharged to the recommended storage condition.
- 4) It shall be kept in dry condition of low humidity, especially be free from high temperature.
- 5) Do not storage the battery near heat sources, nor in a place subject to direct sunlight to storage in warehouse.

Prohibition Clause

- 1) Do not throw the battery into fire, nor heat the battery.
- 2) Do not disassemble nor modify the battery Pack.
- 3) Do not leave the battery in a place of high temperature.(45°C or more)
- 4) Do not immerse battery in water, nor leaving in high moisture.
- 5) Do not add strong shock, nor drop the battery.
- 6) Do not solder lead directly to the battery body.
- 7) Do not heat nor solder the terminals of the battery.

Your power scooter is designed for minimal maintenance. However, like any motorized vehicle it requires routine maintenance. To keep your S21F for years of trouble-free operation, we recommend you follow the following maintenance checks as scheduled.

DAILY CHECKS

- Visual check on the conditions of tires.
- Inspect the battery condition meter on the controller to determine if batteries need to be charged.

MONTHLY CHECKS

- Visually inspect the controller harnesses. Make sure that they are not frayed, cut or have any exposed wires.

SEMI-ANNUAL CHECKS

Check the motor brushes. We recommended that your authorized dealer inspect the brushes every six months or sooner if your power scooter is not operating smoothly. If inspection determines excessive wear on the brushes, they must be replaced or motor damage will result.

CHECKS:

- Make sure to keep the controller clean while protecting it from rain or water. Never hose off your power scooter or place it in direct contact with water.
- Keep wheels free from lint, hair, sand and carpet fibers.
- Visually inspect the tire tread. If less than 1mm (1/32"), please have your tires replaced by your local dealer.
- All Upholstery can be washed with warm water and mild soap. Occasionally check the seat and back for sagging, cuts and tears. Replace if necessary. Do not store your scooter in damp or humid conditions as this will lead to mildew and rapid deterioration of the upholstery parts.
- All moving mechanism will benefit from simple lubrication and inspection. Lubricate using petroleum jelly or light oil. Do not use too much oil, otherwise small drips could stain and damage carpets and furnishings etc.
- Always perform a general inspection of the tightness of all nuts and bolts.

Cleaning and Disinfection

- Use a damp cloth and mild, non-abrasive cleanser to clean the plastic and metal parts of your power scooter. Avoid using products that may scratch the surface of your power scooter.
- If necessary, clean your product with an approved disinfectant. Make sure the disinfectant is safe for use on your product before application. Follow all safety instructions for the proper use of the disinfectant and/or cleaning agent before applying it to your product. Failure to comply may result in skin irritation or premature deterioration of upholstery and/or power scooter finishes.

Dynamic 50 AMP CONTROLLER: Your power scooter is fitted with DYNAMIC controller, which continuously monitors the operating conditions of your power scooter. If it detects a problem it will indicate with error message by flashing light on the power ON/ OFF light. You must count the number of the flash, and see the list to check what kind of error has happened according to the number)

If, when powered up, there is an error with the system, then the status indicator will flash red. The number of flashes will indicate the type of error.

These are described in the table below.

No. of Flashes	Description	Meaning
1	Battery low	Recharge the batteries
2	Low battery fault	The batteries have run out. Recharge the batteries. Check the battery and associated wiring
3	High battery fault	Battery voltage is too high. Due to overcharging or steep descent. Reduce speed if travelling down a slope.
4	Time out or controller too hot	The scooter may have stalled. The scooter off and leave for a few minutes. Check motor is not faulty.
5	Park brake fault	Check the scooter is not in freewheel mode. Check park brake and wiring.
6	Drive inhibit	Out of neutral at power up and battery charge connected. Release wigwag paddle and remove charger. Wigwag may require recalibration.
7	Speed Pot Fault	Check speed pot and throttle pot are not faulty.
8	Motor voltage fault	Check the motor, connectors and wiring are not faulty
9	Other error	Check all connections and wiring. Possible controller fault.

Note: If you experience any technical problems, it is recommended that you check with your local dealer before attempting to troubleshoot on your own.

The following symptoms could indicate a serious problem with your power scooter.

Contact your local dealer if any of the following arises:

1. Motor noise
2. Frayed harnesses
3. Cracked or broken connectors
4. Uneven wear on any of tires
5. Jerky motion
6. Pulling to one side
7. Bent or broken wheel assemblies
8. Does not power up
9. Powers up, but does not move

- ① HEADLIGHT SWITCH WIRING
- ② SPEED ADJUSTING KNOB
- ③ HANDLE BAR UPPER COVER
- ④ SPEED POTENTIOMETER WIRING
- ⑤ LED AMMETER LI BATTERY
- ⑥ UPPER CONTROL PC BOARD
- ⑦ THROTTLE ASSEMBLY
- ⑧ SPEED WIGWAG
- ⑨ HORN BUTTON WITH WIRING
- ⑩ HANDLE GRIP
- ⑪ HANDLE BAR
- ⑫ E TYPE BUCKLE
- ⑬ PLUG OF HANDLE BAR
- ⑭ BUZZER
- ⑮ PLUG OF STEM
- ⑯ STEERING STEM BEARING
- ⑰ PLUG
- ⑱ HANDLE TUBE WELDING
- ⑲ LOCKING KNOB
- ⑳ PEDAL PIPE WELDING
- ㉑ FRONT UPPER COVER
- ㉒ PUSH TUBE WELDING
- ㉓ FRONT FRAME WELDING
- ㉔ FRONT BOTTOM COVER

- ㉕ STEERING AXLE WELDING
- ㉖ HEADLIGHT
- ㉗ RUBBER BUMPER
- ㉘ WELDED FRONT WHEEL AXLE
- ㉙ FRONT SUSPENSION ASM
- ㉚ FRONT FENDER
- ㉛ FRONT WHEEL
- ㉜ FRONT POST SLIDE WELDING
- ㉝ INNER CROSS BAR
- ㉞ OUTER CROSS BAR
- ㉟ ACTUATOR
- ㊱ NEEDLE BEARING
- ㊲ SLIDING TUBE
- ㊳ POSITIONING ROD
- ㊴ BOTTOM PIPE WELDING
- ㊵ CARPET
- ㊶ ASSISTIVE WHEEL
- ㊷ MAIN FRAME WELDING

- ㊸ BATTERY COVER
- ㊹ UPPER BODY COVER
- ㊺ ELECTRIC FOLDING CONTROL BOX
- ㊻ UNDER BODY COVER
- ㊼ CHAIR
- ㊽ CONTROLLER
- ㊾ SEAT BELT
- ㊿ ANTI-TIPPING WHEEL
- ① TRANSAXLE
- ② TURN INNER TUBE
- ③ REAR WHEEL
- ④ CENTER WHEEL COVER
- ⑤ METAL BUTTONS WITH GREEN LIGHT
- ⑥ TURN INNER TUBE
- ⑦ SEAT OUTER FRAME WELDING
- ⑧ METAL BUTTONS WITH RED LIGHT
- ⑨ AFTER THE DECORATIVE COVER
- ⑩ REAR TAILLIGHT
- ⑪ METAL OVAL MARK
- ⑫ LITHIUM BATTERY
- ⑬ BODY PROTECTION COVER
- ⑭ CHARGER
- ⑮ COUPLING BOLT

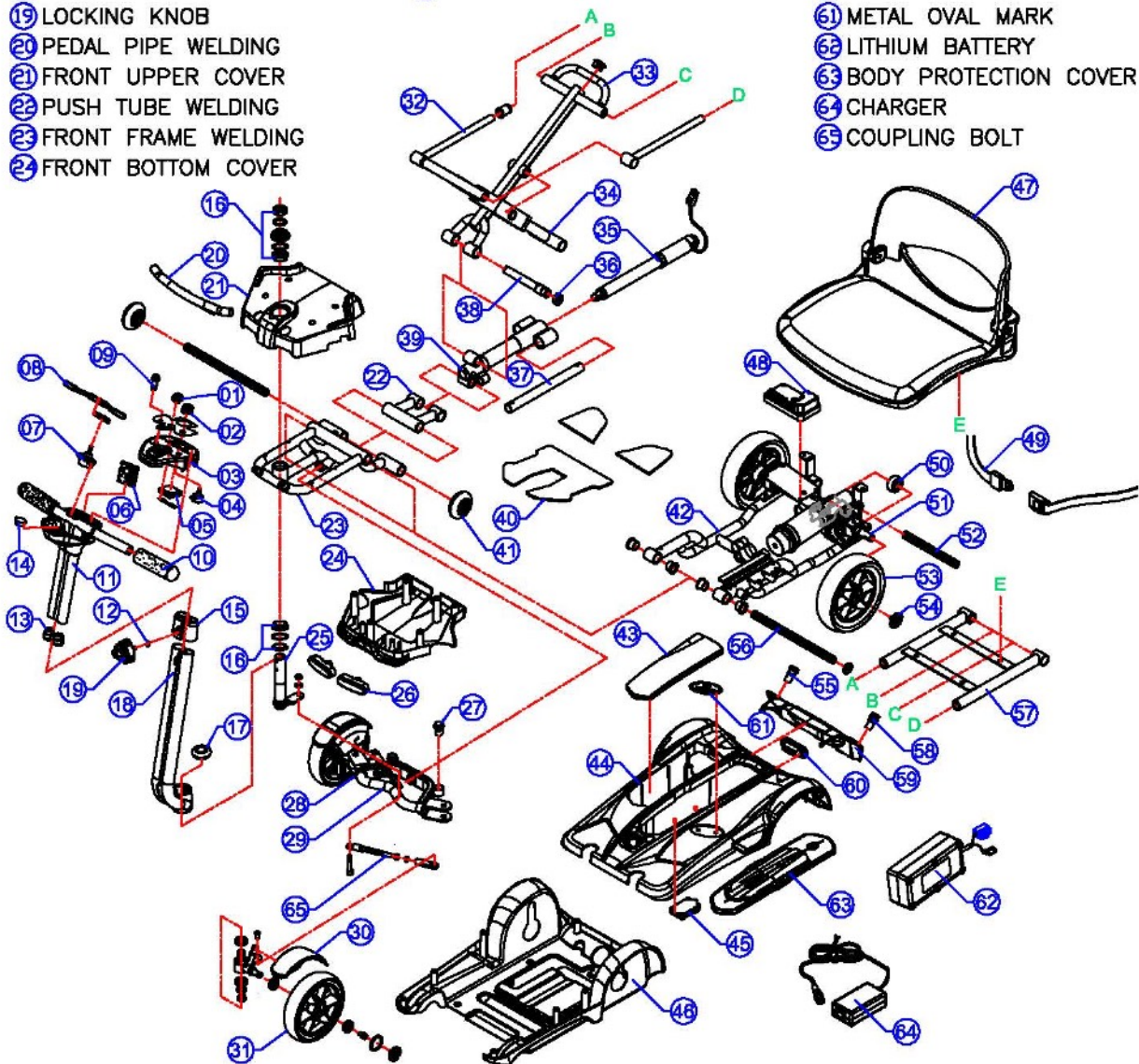

Quality/ Warranty Declaration

Products are to be fit for purpose and of excellent quality and performance. For valid warranty claims Heartway will, at their discretion, replace/ repair/ refund items mutually agreed to be defective.

Heartway's Warranty as Following:

- Frame: Two-year limited warranty
- Controllers: One-and-a-half-year limited warranty
- Electronic Components and Charger: One-year limited warranty
- Warranty Exclusion. The following items are not covered by warranty.

 Motor brushes

 Wheel Tires

 Arm Pads

 Seat Cushion

 Fuses / Bulbs

 T tiller Cover

 Rear Shroud

 Front Shroud

 Batteries and Consumable parts

Any damage or defect of any nature occurring from the misuse, abuse of the product, improper operation or improper storage is not to be covered. The warranty is to start from the date of arrival (maximum 60 days after dispatch from Heartway) of our products.

(01) 0 4719871 230190 (11) 200622 (10) HSK001 (21) B206001

 2020-06-22

 LOT HSK001

 SN B206001

Trade Name: S21F POWER SCOOTER ITEM: 13094028

 Heartway Medical Products Co., Ltd
No.18, Jingke Central 1st Rd., Nantun Dist Taichung City 40852, Taiwan
Manufacturer <http://www.heartway.com.tw>

 European Authorized Representative
Emergo Europe
Prinsessegracht 20 2514 AP The Hague The Netherlands
Distributor :
Address :
Maximum User Weight 115 kgs
Indoor use only , Class A

 Attention: Read the user manual before use

 2025-06



 MD

 CE

 -10°C 45°C

 www.heartway.com.tw



Heartway Medical Products Co.,LTD

No.18, Jingke Central 1st Rd., Nantun Dist., Taichung City 408, Taiwan (R.O.C.)

TEL:+886-4-2358-0537 FAX:+886-4-23590786

E-mail: sales@heartway.com.tw

<http://www.Heartway.com.tw>

